

Sectional And Tilting Door Opener Installation Instructions and User Guide

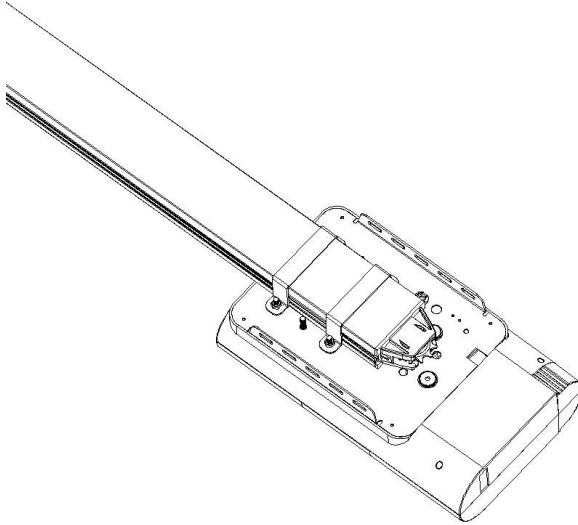

FS 1500

1500N

S/N

WARNING

Please read the manual carefully before installation and use.

The installation of your new door opener must be carried out by a technically qualified or licensed person.



Attempting to install or repair the door opener without suitable technical qualification may result in severe personal injury, death and / or property damage.

CONTENTS

Important Safety Recommendations.....	1
Product Description & Features.....	2-3
Pre-Installation Recommendations	4
Installation (Wall Bracket & Door Bracket)	4
Installation (Aluminum rail & Opener head)	5-6
Battery Backup Assembly (optional).....	6
Display Menu Instructions.....	7
Programming Instructions.....	7-17
Terminal Introduction and Application.....	18-19
Manual Disengagement.....	20
Maintenance.....	20
Technical Specifications.....	21
Parts Listing.....	22
Common Fault & Solutions	23-24

IMPORTANT SAFETY RECOMMENDATIONS

FAILURE TO COMPLY WITH THE FOLLOWING SAFETY RECOMMENDATIONS MAY RESULT IN SERIOUS PERSONAL INJURY, DEATH AND / OR PROPERTY DAMAGE.

1. **PLEASE READ CAREFULLY AND ADHERE TO ALL SAFETY AND INSTALLATION RECOMMENDATIONS.**
 2. The opener is designed and manufactured to meet local regulations. The installer must be familiar with local regulations required in respect of the installation of the opener.
 3. Unqualified personnel or those persons who do not know the occupational health and safety standards being applicable to automatic gates and other doors, must in no circumstances carry out installations or implement systems.
 4. Persons who install or service the equipment without observing all the applicable safety standards will be responsible for any damage, injury, cost, expense or claim whatsoever any person suffered as a result of failure to install the system correctly and in accordance with the relevant safety standards and installation manual whether directly or indirectly.
 5. For additional safety we strongly recommend the inclusion of Photo Beam. Although the opener incorporates a pressure sensitive Safety Obstruction Force system the addition of Photo Beam will greatly enhance the operating safety of an automatic garage door and provide additional peace of mind.
 6. Make sure that the garage door is fully open & stationary before driving in or out of the garage.
 7. Make sure the garage door is fully closed & stationary before leaving.
 8. Keep hands and loose clothing off the opener and garage door all the time.
 9. The Safety Obstruction System is designed to work on STATIONARY objects only. Serious personal injury, death and / or property damage may occur if the garage door comes into contact with a moving object
 10. This appliance is not intended for use by persons (including children) with reduced physical, sensory or mental capabilities, or lack of experience and knowledge, unless they have been given supervision or instruction concerning use of the appliance by a person responsible for their safety. Children should be supervised to ensure that they do not play with the appliance.
- 
11.  Waste electrical products should not be disposed of with household waste. Please recycle where facilities exist. Check with your local authority or retailer for recycling advice.
 12. If the supply cord is damaged, it must be replaced by the manufacturer, its service agent or similarly qualified persons in order to avoid a hazard.
 - **WARNING:** Important safety instructions. It is important for the safety of persons to follow all instructions. Save these instructions.
 - Do not allow children to play with door controls. Keep remote controls away from children.
 - Watch the moving door and keep people away until the door is completely opened or closed.
 - Take care when operating the manual release since an open door may fall rapidly due to weak or broken springs, or being out of balance.
 - Frequently examine the installation, in particular check cables, springs and mountings for signs of wear, damage or imbalance. Do not use if repair or adjustment is needed since a fault in the installation or an incorrectly balanced door may cause injury.
 - Each month check that the drive reverses when the door contacts a 50 mm high object placed on the floor. Adjust if necessary and recheck since an incorrect adjustment may present a hazard, for drives incorporating an entrapment protection system depending on contact with the bottom edge of the door.
 - Details on how to use the manual release.
 - Information concerning the adjustment of the door and drive.
 - Disconnect the supply when cleaning or carrying out other maintenance.
 - The installation instructions shall include details for the installation of the drive and its associated components.

PRODUCT DESCRIPTION & FEATURES

1. Obstruction force adjustment

The minimum force display “1” and it can be adjusted upward. Display “5” means the maximum force.

2. Travel speed adjustment

“8” appears on the display means the 80% of the travel speed. Display “A” means the full speed 160mm/s or 200mm/s.

3. Reversal height adjustment

“0” appears on the display means the door will rebound to the top. Display “1~9” means the door will rebound to the position of the whole travel. One tenth to Nine tenth of the whole travel etc.

4. Partial open/height

“0” appears on the display means close the partial open function. Display“1~9” means to set the different partial open position of the whole travel.

5. Transmitter button recognition function

“0” appears on the display means the buttons recognition function is closed. Display“1” means the buttons recognition function is open.

6. Codes memory quantity

“A” appears on the display means the maximal code memory quantity is 50pcs. Press UP/DOWN button once, to increase or decrease quantity. The code memory quantity is set on 5pcs*N, N=1~9. (The quantity is the multiple of 5).

7. Maintenance alarm

“” appears on the display and led light flashes 10 times quickly means the garage door and motor need total maintenance.

8. Automatic safety reverse

Automatic stop / automatic reverse are controlled by our software of circuit boards. We are circumspect to protect your children, pet or other goods.

9. Soft start / Soft stop

Ramping speed up and down at the start and end of each cycle reduces stress on the door and opener for longer life, and makes for quieter operations.

10. Auto-Close

Auto- Close ensures peace of mind and keeps your house secure by automatically closing the door upon entering or exiting the garage.

11. Self learning open and close obstruction force

The amount of opener power for different stages of the door’ s travel is learnt during setup and is constantly re-profiled. Opener force measurement automatically adjustment in a suitable range.

12. Electronic limit, simple adjustment.

You only need control the limit setup from control panels to adjust it exactly, the simple and quick process for any peoples.

13. Available terminal for Photo beams & Extra receivers & Wire or wireless wall switch & Caution light & Pass door protection device & Fire alarm system.

14. Energy saving - L.E.D courtesy light

9 minutes L.E.D light delay, switching on with each cycle to illuminate your darkened garage.

15. Battery backup available

Openers could be supplied power with our battery backup once the power failure at your home.

16. Self-Lock in gear motors

Gear motor will self-lock with its disengagement systems.

17. Manual release

Don't worry about the power failure, the manual release system is a solution for operation the door at any time.

18. Transmitter technology

Rolling Code technology (7.38×10^{19} Combinations), 433.92 MHz frequency, 4 channels design to ensure you can control 4 different doors with one transmitter.

19. Applications

With as little as 30mm required between the ceiling and the highest point of the door travel, the opener can be flush mounted for low headroom applications.

20. Fire alarm function

Connect to your fire alarm system through the FA interface. When your alarm system is turned on, the door will be forced to open. Any other control and remote control will be invalid. After the alarm is over, the control will be restored. (Fig. 12)

21. Metal bottom plate, stronger and security.

22. Up / Down moving operation buttons (UP / DOWN)

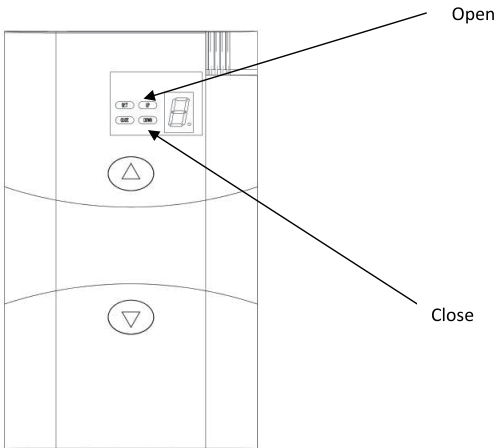

PRE-INSTALLATION RECOMMENDATIONS

1. Garage door must be able to be lifted and closed easily by hand and without much effort. A well balanced & sprung door is critical for proper installation.
2. The garage door opener can't compensate for a badly installed garage door and should not be used as a solution for a "hard to open" door.
3. If the unit is being installed on an existing door, make sure any existing locking devices are removed or warranty will be void.
4. An approved outlet must be installed near where the opener is begin installed.
5. There should be a minimum gap of 30mm between the bottom of the chain drive rail and the top of the garage door at its closest point. (refer to Fig 1.)

Important note: As for additional safety rules, we strongly recommends the fitting of Photo Electric safety beams on all installations.

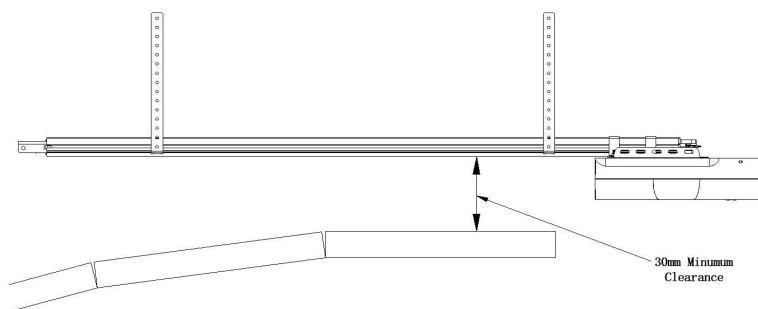

Figure 1

INSTALLATION INSTRUCTIONS

Mount Wall Bracket and Door Bracket (Fig2)

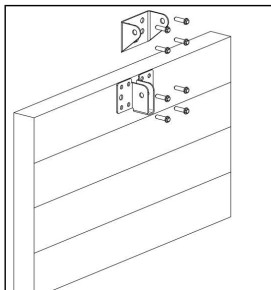

Figure 2

Wall Bracket - Close the garage door and measure the garage door width at the top and mark the centre. Locate and mount the wall bracket 2cm-15cm above the door on the inside wall.

(Depend on the actual installation space).

Door Bracket - Fix the door bracket to a structural part of the door as close to the top edge as possible.

Installation (Aluminum rail & Opener head)

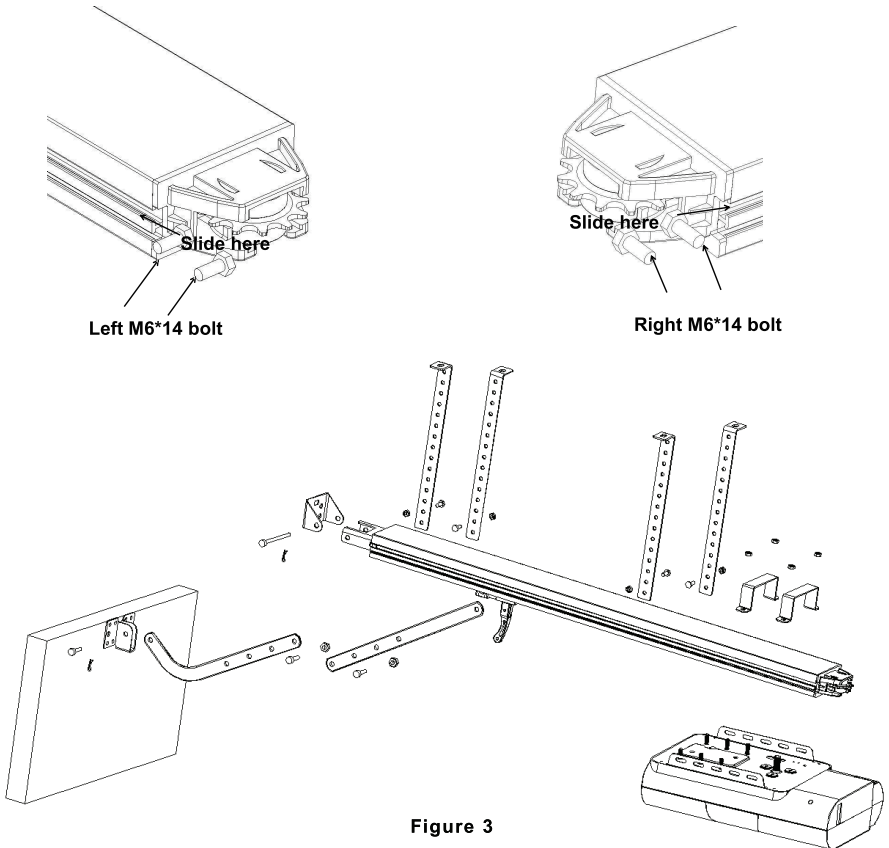

Figure 3

STEP1 (Fig.3)

Important: Firstly, slide 4pcs M6 x 14 bolts from the slots on both sides of the aluminum track. 2pcs on the right, 2pcs on the left. And later will be used to lock the 4pcs "L" mounting bracket with 4pcs M6 nuts.

STEP2 (Fig.3)

Then attach the opener head to the aluminum track. Assembly the 2pcs "U" Hanging brackets with M6 nuts supplied.

STEP3 (Fig.3)

Place the aluminum track and opener head assembly centrally on the garage floor, with the open head furthest away from the door. Lift the front of the track up to the door bracket. Insert the pivot pin and secure it with the split pin supplied.

STEP4 (Fig.3, Fig.4)

Lift and support the opener head (with a ladder) so it is positioned centrally and level. Fix the opener and track on ceiling by 4pcs "L" mounting bracket & 4pcs slide M6*14 bolt & 4pcs slide M6 nut.

WARNING: Do not allow children around the door, opener or supporting ladder serious injury and/or damage may result from failure to follow this warning.

STEP5 (Fig.3, Fig.5)

Connect the straight arm to the bent arm with the M8 bolt. Position and bolt the arms to the top edge of the door using the M8 nut & M8*16 bolt supplied.

STEP6

Lift the garage door until the shuttle locks into the drive chain.

Now, ready to program the openers.

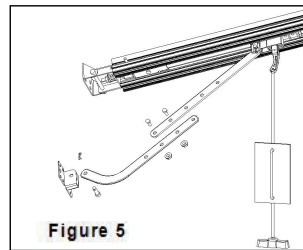
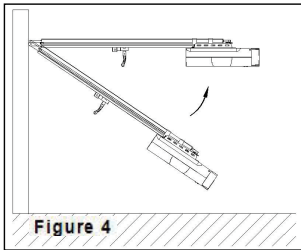

Battery Backup Assembly(optional)
Build-in Lithium Battery

STEP1 (Fig.6)

Slide the battery case and connect the battery wire like the photo.

STEP2 (Fig.7)

Join the battery to opener, find the Fig.7.

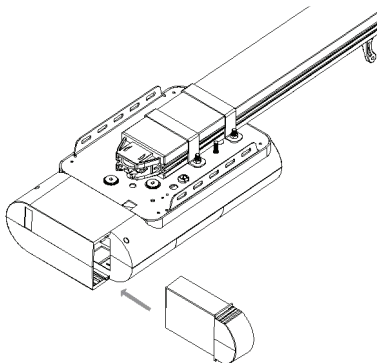

Figure 6

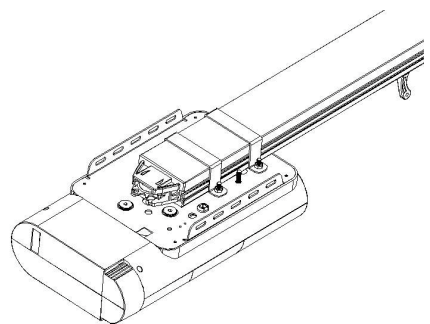
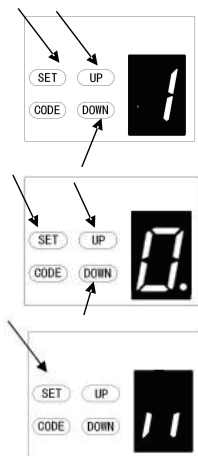

Figure 7

DISPLAY MENU INSTRUCTIONS



FEATURES SETTINGS:

- a) Press and hold **SET** button until "1" appears on the display then release the button.
- b) Press **UP / Down** button, then it displays the number "1-E".
- c) Press **Set** button to confirm the feature you need to set, then it enters to the interface for detail setting of the appointed feature.
- d) In the detail setting interface display "0-A" with flash dot.
- e) Press **UP / Down** button to choose the feature you need to set.
- f) Press **SET** button to confirm the set and it will back to standby status automatically and display "I".

PROGRAMMING INSTRUCTIONS

Pre- Instruction for programme buttons

1. Short click **SET** button : When it standby, it will clear the error, alarm display, and return to normal display.
2. Short click **CODE** button :
 - (In the Setting Status) Exit the current operation and return to the standby interface.
 - When it standby, press the code, A dot will be indicated in the corner, now entering the code leaning mode.

Now first click the button on the hand transmitter you want to use, the dot may disappear ,then press again the same button on the hand transmitter, the dot will flash, here, the code learning is finished.

3. Short press **UP** button : The door will open.
4. Short press **DOWN** button : The door will close.
(When the door is opening or closing, it will stop if you press any key.)
5. Long press **SET** button : Enter function setting interface.
6. Long press **CODE** button : Press and hold **CODE** button until a C is indicated on the display. All stored remotes will be deleted.
7. Long press **UP** button : Increase the resilience. (Keep press DOWN button, after 4 seconds, it will scroll to display 0-1-2, choose the number you want. 1=increase 25% 2=increase 50%)
8. Long press **DOWN** button : Restore Factory Settings

Keep press **DOWN** button, after 4 seconds, it will scroll to display , then the garage door opener will restart.

Restart means all settings are back to factory settings, all learning things need to be done again except the transmitter code learning.

PROGRAMMING INSTRUCTIONS

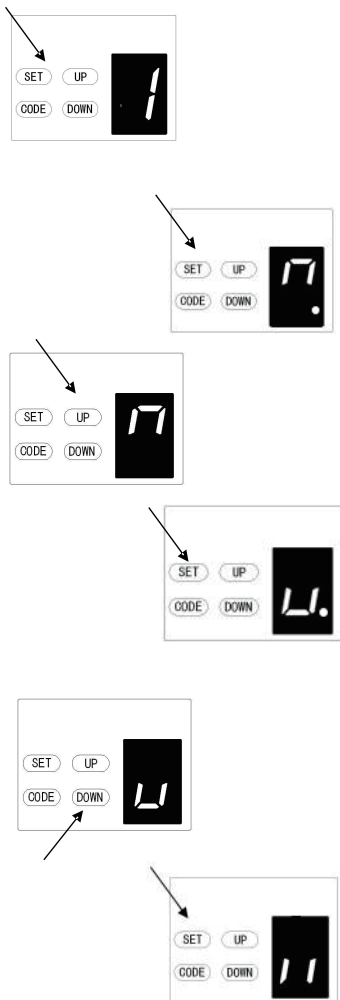

1. PROGRAMMING OPEN & CLOSE LIMITS

- Press and hold **SET** button to enter this function setting until "1" appears on the display then release the button.
- Press the **SET** button again. The door opener is now in Programming Mode. And then you will see "n" with dot appears on the display.
- Press and hold the **UP** button until the door reaches the desired open position, you will see "n" without dot on the display.
- Press **SET** button to confirm the open position, then you will see "u" with dot on the display.
- Next press and hold the **DOWN** button until the door reaches the desired close position, you will see "u" without dot on the display.

NOTE: For fine adjustments toggle **UP & DOWN** buttons.

- Now press the **SET** button to confirm the close position, then you will see "11" on the display.

After confirm the close position, the door will now cycle open and close to set the travel limits and force sensitivity adjustments. The door is now set for normal operation.

CAUTION: After the cycle open and close, there will be figures shown on the display (0~9), "0" means the doors is balanced, the smaller figure means the better door balance, strongly recommend that the figure need to be smaller than the power force.

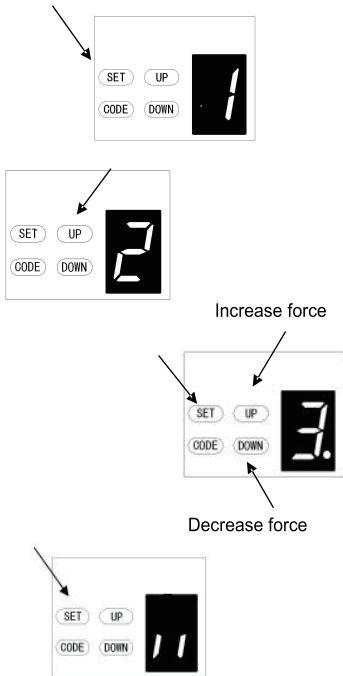

2. OBSTRUCTION FORCE ADJUSTMENT

CAUTION: The obstruction force adjustment is set automatically during programming. Normally no adjustment is necessary.

a) Press and hold **SET** Button until "1" appears on the display, next press the **UP** Button until "2" appears on the display to enter this function setting then release the button.

b) Press the **SET** button again, The unit is now in force adjustment mode. And then you will see a figure "3" with flash dot appears on the display.

c) Press the **UP** button to increase the force setting or the **DOWN** button to decrease the force setting.

The minimum force is "1" and it can be adjusted upward. The maximum force is "5".

d) Press **SET** button to confirm the set and it will back to standby status automatically and display "11".

NOTE: The force is set on "3" as standard in factory.

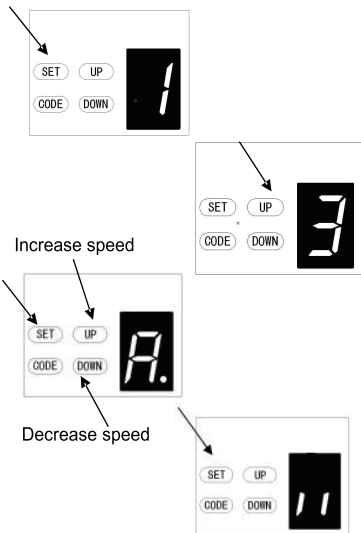

3. TRAVEL SPEED SETTING

CAUTION: If you changed the speed again, it will cancel the previous travel limit. The speed adjustment function will be available only after you reset the travel limit.

a) Press and hold **SET** Button until "1" appears on the display, next press the **UP** button until "3" appears on the display to enter this function setting then release the button.

b) Press the **SET** button again. The unit is now in speed adjustment mode. And then you will see a letter "A" with flash dot appears on the display.

c) Press the **UP & DOWN** button to choose the speed. Figure "8" means the 80% of the travel speed. Figure "A" means the full speed.

d) Press **SET** button to confirm the set and it will back to standby status automatically and display "11".

NOTE: The travel speed is set on full speed "A" as standard in factory.

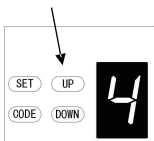
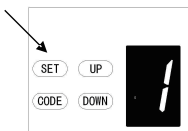

Increase time

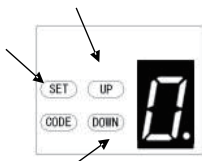

Decrease time

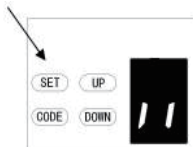

4. AUTOMATIC CLOSING&TIME SETTING

NOTE: We recommend that Safety Photo Beams be used in any installation where the Auto Close function is enabled.

a) Press and hold **SET** Button until "1" appears on the display, next press the **UP** button until "4" appears on the display to enter this function setting then release the button.

b) Press the **SET** button again, the unit is now in automatic close adjustment mode. And then you will see a figure "0" with flash dot appears on the display.

c) Press **UP / Down** button once to set the auto close time (0~9).

d) Press **UP** button to increase the time, or **DOWN** button to decrease the time.

The close time is 15second*N, N=0~9. The maximum time is 135s. To disable Auto Close Function, set time to zero (0).

e) Press **SET** button to confirm the set and it will back to standby status automatically and display "11".

NOTE: 1.The closing time is set on "0" as standard in factory.

2. If the Photo Cell Function is on, and it's broke by the obstruction, the auto close time will stop for a while, and then continue the automatic close time again.

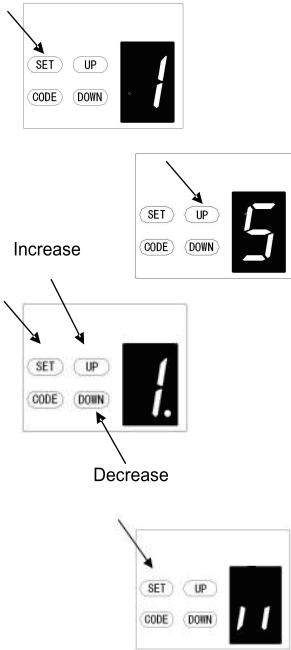

5. AUTOMATIC CLOSING CONDITION SETTING

a) Press and hold **SET** Button until "1" appears on the display, next press the **UP** button until "5" appears on the display to enter this function setting then release the button.

b) Press the **SET** button again. The unit is now in automatic close condition adjustment mode. And then you will see a figure "1" with flash dot appears on the display.

c) Press **UP / Down** button once to set the auto close condition. You can choose "1" or "2" set.

Figure "1" means, the door only can auto close while in the open limit position.

Figure "2" means, the door can auto close while the door is in any position.

d) Press **SET** button to confirm the set and it will back to standby status automatically and display "11".

NOTE: 1. The closing condition is set on "1" as standard in factory.

2. The door will only automatic close while in its opening process, but can't automatic close after it is stopped while in its closing process.

6. LED OFF DELAY TIME SETTING

a) Press and hold **SET** Button until "1" appears on the display, next press the **UP** button until "6" appears on the display to enter this function setting then release the button.

b) Press the **SET** button again. The unit is now in LED off delay time adjustment mode. And then you will see a figure "3" with flash dot appears on the display.

c) Press **UP / Down** button once to set the LED off delay time (1~9).

d) Press **UP** button to increase the time, or **DOWN** button to decrease the time.

The delay time is 1 minute*N, N=1-9. The maximum delay time is 9 minutes.

e) Press **SET** button to confirm the set and it will back to standby status automatically and display "11".

NOTE: The LED off delay time is set on "3" as standard in factory.

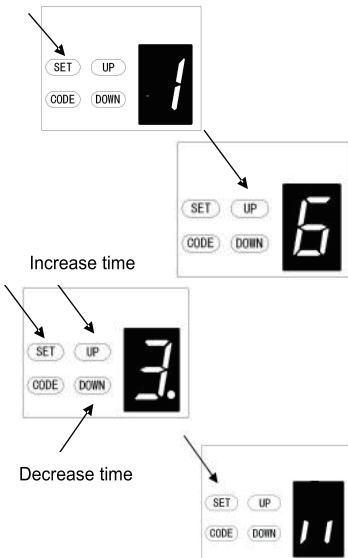

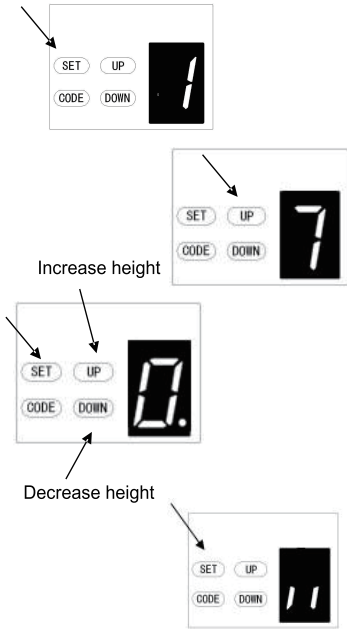

7. REVERSAL HEIGHT SETTING

a) Press and hold **SET** Button until “1” appears on the display, next press the **UP** button until “7” appears on the display to enter this function setting then release the button.

b) Press the **SET** button again. The unit is now in reversal height adjustment mode. And then you will see a figure “0” with flash dot appears on the display.

c) Press **UP / Down** button once to set the reversal height while closing (0~9).

d) Press **UP** button to increase , or **DOWN** button to decrease.

Figure “0” means the door will rebound to the open limit position. Figure “1~9” means the door will rebound to the position of the whole travel. One tenth to Nine tenth of the whole travel etc...

e) Press **SET** button to confirm the set and it will back to standby status automatically and display “11”.

NOTE: The reversal height is set on “0” as standard in factory.

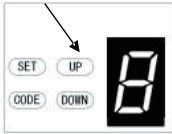
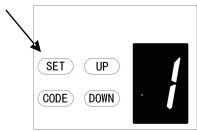

Increase

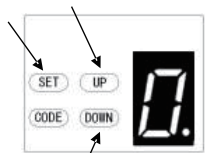

Decrease

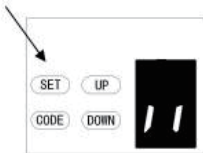

8. PARTIAL OPEN/HEIGHT SETTING

a) Press and hold **SET** Button until "1" appears on the display, next press the **UP** button until "8" appears on the display to enter this function setting then release the button.

b) Press the **SET** button again. The unit is now in partial-open/height adjustment mode. And then you will see a figure "0" with flash dot appears on the display.

c) Press **UP / Down** button once to select if you want to open the partial open function or set the partial open height. (0~9). Press **UP** button to increase , or **DOWN** button to decrease.

Figure "0" means close the partial open function.

Figure "1~9" means set the partial open position of the whole travel. **One tenth to Nine tenth of the whole travel etc...**

d) Press **SET** button to confirm the set and it will back to standby status automatically and display "11".

NOTE: 1. The partial open/height is set on "0" as standard in factory.

2. If you open the partial open/height function, the buttons' recognition function will be disabled.

3. Other details please refer to the Instruction manual of the remote carefully.

4. If you enabled the partial open function then disabled this function later, please notice that only the coded button you leaned in the beginning can control the opener now.

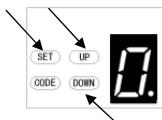
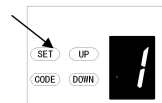

Buttons recognition function is open



Buttons recognition function is closed

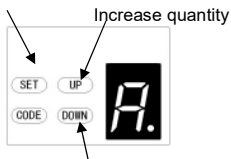
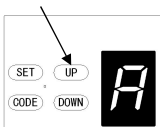

Decrease quantity



9. TRANSMITTER BUTTONS RECOGNITION FUNCTION SETTING

a) Press and hold **SET** button to enter this function setting until "9" appears on the display then release the button.

b) Press the **SET** button again. The unit is now in buttons recognition function adjustment mode. And then you will see a figure "0" with flash dot appears on the display.

c) Press **UP / Down** button once to select if you want the upper 3 buttons can control the only one opener, or only the separate coded button can control the opener.

Figure "0." means the buttons recognition function is open. If you coded first button with first opener, then the first button will be the only button on the remote can control the first opener. It's suit for the users who have more than 1 automation doors/gates at home. At most 4.

Figure "1." means the buttons recognition function is closed. It means if you coded one of the upper 3 buttons with 1 opener, then all the upper 3 buttons on the remote can control this opener. It's suit for the users who only have 1 automation door at home. The bottom 4th button is to control the LED strip. (If you installed On-Rail LED strip optionally.)

d) Press **SET** button to confirm the set and it will back to standby status automatically and display "11".

NOTE: 1. The buttons recognition is set on "0." as standard in factory.

2. After you changed the buttons un-recognition into recognition, please notice that only the coded button can control the opener.

A. CODES MEMORY QUANTITY SETTING

a) Press and hold **SET** Button until "1" appears on the display, next press the **UP** button until "A" appears on the display to enter this function setting then release the button.

b) Press the **SET** button again, the unit is now in remote quantity adjustment mode. And then you will see a figure "A" again, but with flash dot appears on the display.

c) Press **UP / Down** button once to set the remote quantity. (A or 1-9).

d) Figure "A" means the maximal quantity 50pcs. Press **UP/DOWN** button once to increase or decrease quantity.

The remote quantity is set on 5pcs*N, N=1~9. (The quantity is the multiple of 5)

e) Press **SET** button to confirm the set and it will back to standby status automatically and display "11".

NOTE: The remote quantity is set on "A" as standard in factory.

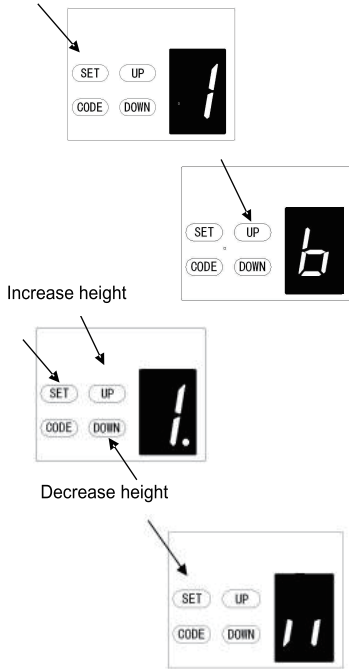

b. REVERSAL HEIGHT IGNORANCE SETTING

a) Press and hold **SET** Button until "1" appears on the display, next press the **UP** button until "b" appears on the display to enter this function setting then release the button.

b) Press the **SET** button again. The unit is now in reversal height ignorance adjustment mode. And then you will see a figure "1" with flash dot appears on the display.

c) Press **UP / Down** button once to set the reversal height ignorance while closing (0~9).

d) Press **UP** button to increase , or **DOWN** button to decrease.

Figure "1~9" means the door will still not rebound even though there's obstacles in its closing path within 1cm~9cm away from the close position. This function is most suitable for the Northern Europe where will always snow on the ground.

e) Press **SET** button to confirm the set and it will back to standby status automatically and display "11".

NOTE: The reversal height is set on "1" as standard in factory.

C. PASS DOOR SWITCH TYPE SETTING

a) Press and hold **SET** Button until "1" appears on the display, next press the **UP** button until "C" appears on the display to enter this function setting then release the button.

b) Press the **SET** button again. The unit is now in the pass door switch type adjustment mode. And then you will see a figure "0" with flash dot appears on the display.

c) Press **UP / Down** button once to set the pass door switch type. You can choose "0" or "1" set.

Figure "0" means, the pass door function is normally open.

Figure "1" means, the pass door function is normally close.

e) Press **SET** button to confirm the set and it will back to standby status automatically and display "11".

NOTE: The pass door switch is set on "0" as standard in factory.

d. PHOTO CELL ON/OFF SETTING

NOTE: Make sure the photo cell has been correctly installed and used Normally Closed contacts to the accessory terminals of the opener.

Also note that the photo beam function must be disabled if NO photo beams are fitted, otherwise the door cannot be closed, and the LED display will show the letter "r" as an indication.

a) Press and hold **SET** Button until "1" appears on the display, next press the **UP** button until "d" appears on the display to enter this function setting then release the button.

b) Press the **SET** button again. The unit is now in the photo cell ON/OFF adjustment mode. And then you will see a figure "0" with flash dot appears on the display.

c) Press **UP / Down** button once to set the photo cell ON/OFF switch. You can choose "0" or "1" set.

Figure "0" means, the photo cell function is closed.

Figure "1" means, the photo cell function is open.

d) Press **SET** button to confirm the set and it will be back to standby status automatically and display "II".

NOTE: The photo cell is set on "0" as standard in factory.

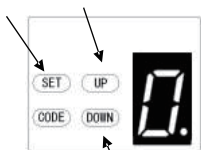
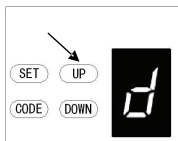
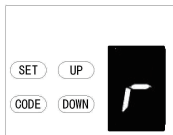

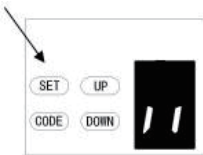
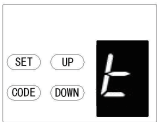
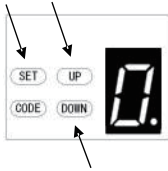
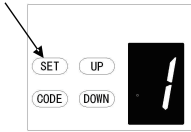

E. MAINTENANCE ALARM--OPERATION CYCLES COUNT SETTING

a) Press and hold **SET** Button until “1” appears on the display, next press the **UP** button until “E” appears on the display to enter this function setting then release the button.

b) Press the **SET** button again. The unit is now in the maintenance alarm adjustment mode. And then you will see a figure “0” with flash dot appears on the display.

c) Press **UP / Down** button, you can select the operation cycles you need the opener to make you notice. You can choose from “1-5” set.

Figure “1” means, after garage door operated to 1000 times, the L.E.D light will flash 10 times quickly after the door stop working every time. In order to make you notice that your garage door need to do maintenance . And at the same time, you will see a figure “t” appears on the display.

Figure “2” means the maintenance alarm count cycle is set on 2000 times.

Figure “3” means the maintenance alarm count cycle is set on 3000 times.

Figure “4” means the maintenance alarm count cycle is set on 4000 times.

Figure “5” means the maintenance alarm count cycle is set on 5000 times.

c) Press **SET** button to confirm the set and it will be back to standby status automatically and display “11”.

NOTE: 1. The operation cycles count is set on “0” as standard in factory.

2. “E” appears on display and led light flashes 10 times quickly means the door lost balance, strong recommend the maintenance for garage doors.

3. “Check” the status, or “ Re-learn” the travel limit after maintenance alarm cautions.

F. OPEN / STOP / CLOSE TERMINALS

The O/S/C facility can be used for an external push button switch to operate the opener. The switch must have voltage free normally open contacts.

Photo beam connection (optional) – Fig.8, Fig.9

Switch control connection (optional) – Fig.8

Remark:

1. Flash (Caution Light) Should be less than 25W.
2. PB (External Push Button) Should be “NO”.

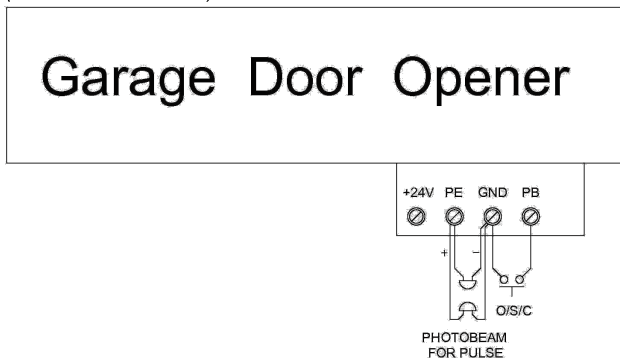
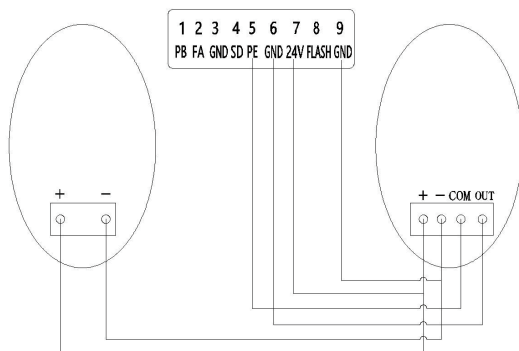

Figure 8



Connection of photo beam/switch control

Figure 9

Other terminal introduction and application

1. The O/S/C interfaces available. (Fig. 10, Fig. 11)

Add a new O/S/C button to open or close the door.

2. Flash light function. (Fig. 10, Fig. 11)

There are corresponding interfaces for this function and provide 24v-35v flash light voltage.

Connect the flash light with DC 24v-28v, current $\leq 100\text{mA}$. When use AC 220V power flash lights, please match an adapter, and wiring as required

3. Pass door (SD) protection (Fig. 10, Fig. 11)

This function ensures that the door can't be opened unless the small pass door is closed.

The door panel won't be damaged.

4. Connect to your fire alarm system through the FA interface. When your alarm system is turned on, the door will be forced to open. Any other control and remote control will be invalid. After the alarm is over, the control will be restored. (Fig. 12)

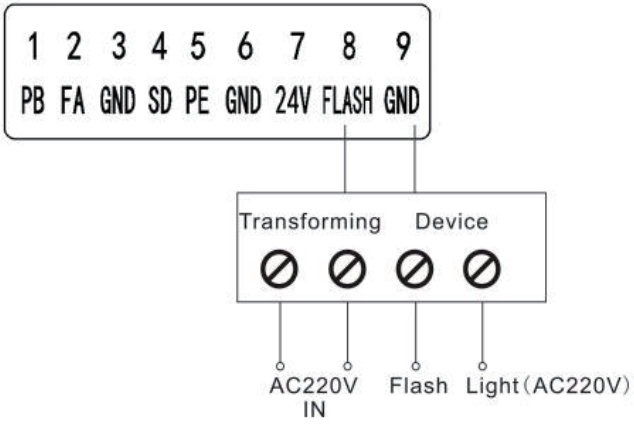

Figure 10

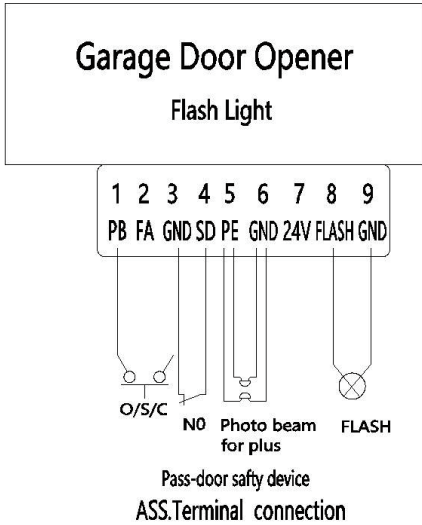

Figure 11

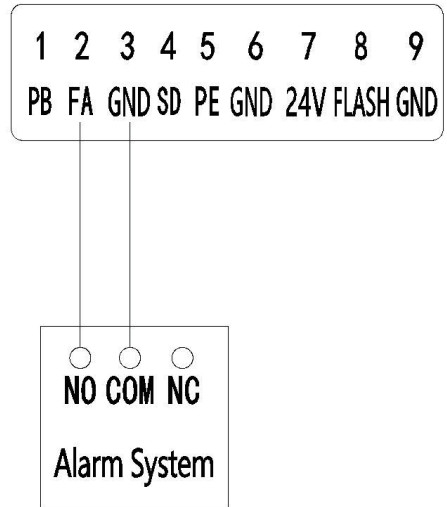

Figure 12

MANUAL DISENGAGEMENT

The opener is equipped with a manual release cord to disengage shuttle and move door by hand while holding the handle down (Fig 13). Pull on the handle to disengage the shuttle. To re-engage the door simply run opener in automatic mode or move door by hand until the trolley engages in the chain shuttle.

In some situations that a pedestrian door is not in state, it is recommended that an external disengagement device should be fitted (Fig 14).

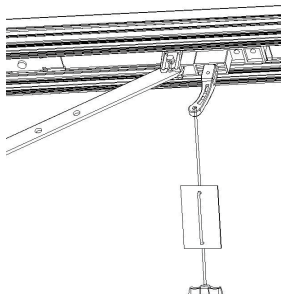

Figure 13

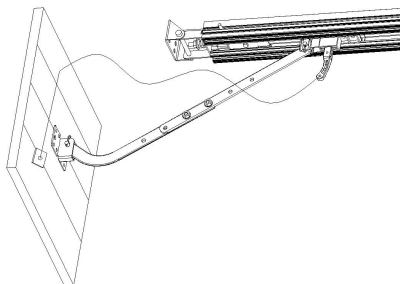

Figure 14

MAINTENANCE

1. No particular maintenance is required for the logic circuit board.
Check the door at least twice a year if it is properly balanced, and all working parts are in good working condition or not.
Check the reversing sensitivity at least twice a year, and adjust if it is necessary.
Make sure that the safety devices are working effectively (photo beams, etc.)
2. LED light strip replacing:
Notice: Make sure the power supply has been cut off before replacing the LED light strip. And ensure the voltage of the new LED light strip is in accordance with the local voltage and the power is within 25 Watt.
Demount the screws on the lamp cover. Take the lamp cover away then twist off the old L.E.D light anti-clockwise. Fix the new L.E.D light and lamp cover.
3. Before installing a caution light, please ensure the rate is within 5 Watt.
4. Regarding the maintenance alarm function, LED light flashes 10 times quickly means the door lost balance, strong recommend the maintenance for garage doors. "Check" the status, or "Re-learn" the travel limit after maintenance alarm cautions.

Notice: A rude operating door can affect the life of the automatic opener due to incorrect loads, and will void the warranty.

TECHNICAL SPECIFICATIONS

	FS 1500
Input voltage	220 - 240V / 110 - 127V, 50–60 Hz
Max. pull force	1500 N
Max. door area	25.0 m ²
Max. door weight	200kg
Max. lift under balanced	50kg
Max. door height	2400 - 5000mm
Drive mechanism	Chain
Opening / Closing speed	190mm / Second
L.E.D	24V / 15pcs LED bulbs
Limit setting	Electronic
Transformer	Overload protection technology
Radio frequency	433.92 MHz
Coding format	Rolling code (7.38 x 10 ¹⁹ Combinations)
Transmitter	2 X
Code storage capacity	50 different codes
Caution light terminal	Included
Working temperature	-40°C - +50°C
Safety protection	Soft start & Soft stop Photo cell & Caution light
Protection level	IP20

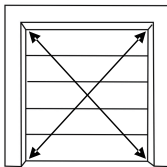

Rated door area: \cong 25.0 m²

FS 1500

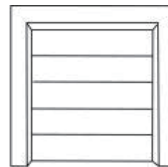

Standard door height: 2400mm
Maximum door height: 5000mm

PARTS LISTING

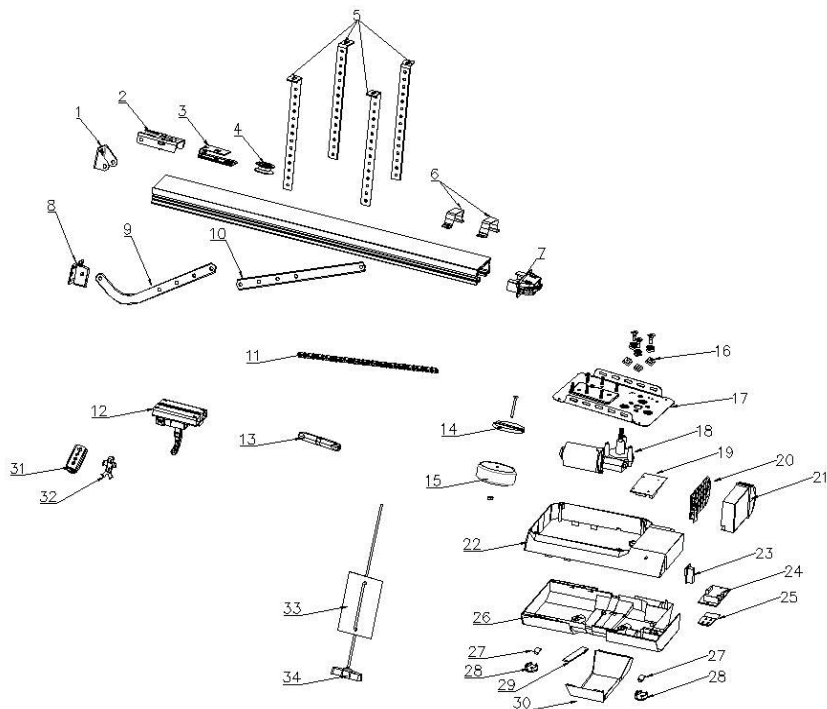











Item	Qty	Description
1	1	Wall bracket
2	1	Track ending bracket
3	1	Wheel bracket
4	1	Chain wheel
5	4	Mounting bracket
6	2	U hanging bracket
7	1	Sprocket assy
8	1	Door bracket
9	1	Bent arm
10	1	Straight arm
11	1	Chain rail
12	1	Trolley assy

Item	Qty	Description
13	1	Chain connection
14	1	Transformer plate
15	1	Transformer
16	1	Rubber pad kit
17	1	Steel bottom base
18	1	DC gear motor
19	1	PCB-1
20	1	Battery bottom cover
21	1	Battery top cover
22	1	Main cover-1
23	1	9P connector
24	1	PCB-2

Item	Qty	Description
25	1	Control panel
26	1	Main cover-2
27	2	Button base
28	2	Button
29	1	L.E.D light
30	1	Middle cover
31	1	Transmitter
32	1	Transmitter bracket
33	1	Caution card
34	1	Release handle
35	1	Motor shaft

Common Fault & Solutions

Fault appearance	Fault cause	Solutions
No any working for openers LCD screen is not bright	1. Power supply 2. Plug wire is loosing	1. Check whether the motor socket is energized 2. Check whether Fuse tube is broken 3. Check whether the low-voltage wire of transformer is connected to the power board 4. Check whether the ribbon cable is plugged 5. Check whether there is 26v AC at the transformer low-voltage side, if there is 26v AC, replace the PCB. If not, replace the transformer
Position missing	System error	Re-set the limit traveling
While learning, the digital display 	Travel less than 30cm or more than 9m	Re-set the limit traveling
Digital display  Opener does not work or stop working	Unstable voltage or door lost balance	1. Check the power supply 2. Adjust the door balance
Opener is not working Digital display 	Fail to learn the up and down limit setting Improperly learn the up and down limit setting	Learn "UP" and "DOWN" limit traveling again follow the manual
LED is always on	The control panel is broken or the power supply board is broken	Replace the control board or power board.
When remoting the door, opener stops automatically after running 10cm Digital display 	Hall sensor wire is loosed or damaged	Open the cover, check the Hall sensor wire, re-plug or replace.
Opener does not work. Hear the relay 'kaka' sound Digital display 	The wire between gear motor and board is loosing	Open the cover and check the wire between gear motor and board.
Opener stops automatically after running 10cm Digital display 	The wire between gear motor and board is plugged inversely	Power off firstly, open the cover and reverse the plug wire between gear motor and board. Re-set limit traveling.
Door is up moving only. Do not work in down moving and the Digital display 	Photo cell function has been effective but without connecting any photo cell device.	Turn off the photo cell function if there is no any photo cell device connected. (Refer the instruction manual) 2. Check if the photo cell is connected correctly, or if there is any obstruction between the photo cell.

The door is fully open, automatically close after some time LED lights flash 4 times	Automatic closing function is turned on	Set the automatic closing time, or turn off the automatic closing function. (Refer the instruction manual)
When the door stops, the caution light is always on	The power board is broken	Replace the power board
LED lights do not work	1. The LED wire is not plugged 2. The LED is broken 3. The circuit board is broken	1. Check the LED wire 2. Replace the LED 3. Replace the circuit board
Door is automatically reversed to the upper limit before the door closed completely	In operation with automatic reverse function The door is not installed correctly There is some block on its moving	1. Check the block position of the door and re-set the limit traveling 2. Increased force number for automatic reverse
Door automatically stops while opening	In operation with automatic protect function when obstruction is detected The door is not installed correctly There is some block on its moving	1. Check the block position of the door and re-set the limit traveling 2. Increased force number for automatic reverse
The remote control cannot be used or the operation distance is short	1. Flat battery 2. Antenna is loosed or not well extended 3. Interference around nearby	1. Replace new battery 2. Extended the antenna on the opener 3. Get rid of interference
Cannot code in the new remotes	New remote control is not compatible with opener	Choose our remote control only
Digital display 	Stored remote code is full	Delete all stored codes (Refer the instruction manual)
Standby, Digital display 	Door in door function effects	Check the door in door switch
The opener is working while the door is not moving	Motor shaft sleeve worn	Replace the motor shaft sleeve
The battery do not supply power	1. Flat battery 2. The battery wire is plugged inversely 3. The battery wire is broken	1. Charge the battery 2. Open the cover, check "+ -" of the battery 3. Replace the battery wire
Other abnormal issues	External devices is not compatible with the opener	Remove all the external devices. If the abnormal issues still exist, replace the circuit board
Digital display 	The Garage door system needs maintenance	The garage door and motor need total maintenance

